



BONFEU
ORIGINAL



PRODUCT RANGE

DUTCH DESIGN



EXPERIENCE MOMENTS OF WARMTH AND ATMOSPHERE

BonFeu stands for a recognizable and unique design and high quality.

We always strive to develop fireplaces that are comfortable to use and are suitable for delicious outdoor cooking. Creative and contemporary designs that anticipate current trends, but always with a certain robustness

that guarantees a long life. Because of these core values,

BonFeu has developed into a leading brand in the world

of fireplaces, firepits and firebowls.





BONSOLO

The BonSolo is one of our smallest fireplaces, but a real eye-catcher. It is equipped with a rotating grill and has a cut-out logo on the front. This logo gives a great effect during fire. The BonSolo has extendable legs which makes it easy to stabilise.

H 126 cm Ø 34 cm
Incl. grill grid and spark screen

■ SKU 3401 ■ SKU 3401R



BONBONO

This timeless mood creator has proven to be a hit for years. Lighting a fire & grilling has never been easier and more atmospheric. Just like the BonSolo, this model comes with a rotating grill as well as extendable legs for optimal stabilisation.

H 165 cm Ø 45 cm
Incl. grill grid and spark screen

■ SKU 4501 ■ SKU 4501R



FEATURES AND BENEFITS

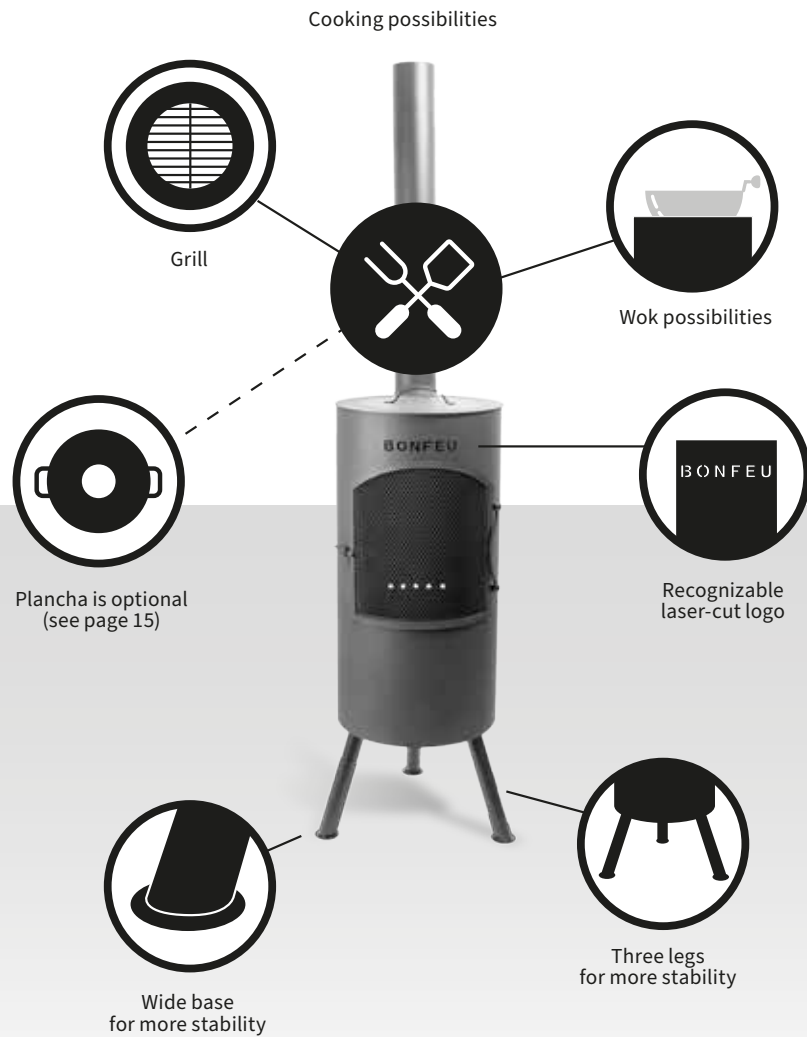

BONTINO

The BonTino fireproof has a diameter of 35 cm. Together with the height of 164 cm, this makes for a wonderful fireproof with barbecue grill and wok with lots of possibilities in the garden.

H 164 cm Ø 35 cm

Incl. grill grid, wok possibility, spark screen and lid.

A plancha is optional (SKU BPR3.400G)

■ SKU 3501 ■ SKU 3501R





BONGIANO SP

The BonGiano SP is a sturdy garden fireplace with grill and wok possibility. The perfect combination of a cosy fireplace with the perks of outdoor cooking.

H 142 cm Ø 30 cm

Incl. grill grid, wok possibility, spark screen and lid.

A plancha is optional (SKU BPR3.400G)

■ SKU 3001 ■ SKU 3001R



BONGIANO LP

This is the big brother of the BonGiano SP. With an ideal height of 142cm grill and wok possibility, it is suitable for outdoor cooking with family and friends.

H 142 cm Ø 30 cm

Incl. grill grid, wok possibility, spark screen and lid.

A plancha is optional (SKU BPR3.400G)

■ SKU 3002 ■ SKU 3002R



OUTDOOR COOKING

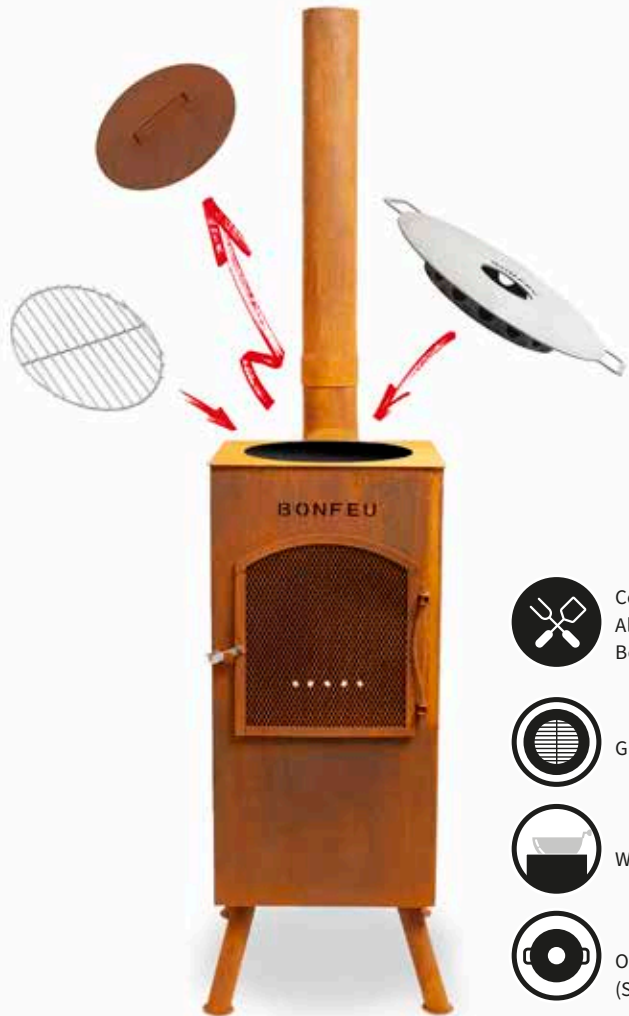

Cooking possibilities
Also on BonGiano LP,
BonGiano SP and BonTino



Grill



Wok possibility



Optional: Plancha
(See page 15)



BONCARRÉ

The BonCarré is a rugged, square model with four distinctive legs. The fireplace is made of solid steel and has a heat-resistant coating. It has the same options for cooking as his round equal: The BonTino.

H 164 cm 35x35 cm

Incl. grill grid, wok possibility, spark screen and lid.

A plancha is optional (SKU BPR3.400G)

■ SKU 3503 ■ SKU 3503R





BONVES 34

Both the BonVes 34 and its bigger brother (BonVes 45) offer great surface for cooking possibilities, combined with a beautiful view of the fire through its perforated steel.

For optimal stabilization, the BonVes has extendable legs.

H 89 cm Ø 34 cm | Incl. grill grid
A plancha is optional (SKU BPR6.450G)

■ SKU 3402 ■ SKU 3402R



BONVES 45

The BonVes 45 is the big brother of the BonVes 34 with a height of 100 cm and diameter of 45 cm. Just like the smaller model, the BonVes 45 has extendable legs and the perfect suitability for using the firepit as a cooking station using the BonFeu Plancha 55 (Ø 55 cm).

H 100 cm Ø 45 cm | Incl. grill grid.
A plancha is optional (SKU BPR6.550G)

■ SKU 4502 ■ SKU 4502R



COOKING ACCESSORIES BONFEU FIREPLACES

Most of the BonFeu fireplaces and firepits are equipped with extras like a grill grid or a possibility for a wok. Besides that, we created the BonFeu Plancha for almost all these fireplaces and firepits. The Plancha is made out of 6 mm thick steel and is created for grilling the most delicious types of food.

There are three sizes available; one suitable for the BonGiano's, BonTino and the BonCarré (Ø 40 cm), one for the BonVes 34 (Ø 45 cm) and one for the BonVes 45 (Ø 55 cm). Very easy to install, user-friendly and a perfect working height to barbecue.



Plancha 40 | SKU BPR3.400G



Plancha V34 | SKU BPR6.450
(Specially for the BonVes 34)



Plancha V45 | SKU BPR6.550
(Specially for the BonVes 45)





BONTON 40

The BonTons are by far the biggest fireplaces that BonFeu produces. The BonTon 40 has a diameter of 40 cm and a height of 145 cm.

H 145 cm Ø 40 cm
Incl. spark screen and ash tray.

■ SKU 4002 ■ SKU 4002R



BONTON 50 AND 60

The BonTon 50 is 50 cm in diameter and 172 cm in height. And the BonTon 60 is 60 cm in diameter and 205 cm in height. These BonTons are truly big and will surely impress your guests.

H 172 cm Ø 50 cm
Incl. spark screen and ash tray.

■ SKU 5002 ■ SKU 5002R

H 205 cm Ø 60 cm
Incl. spark screen and ash tray.

■ SKU 6002 ■ SKU 6002R



BONGIRO

The fireplace's low legs make it a striking appearance compared to its brothers the BonSolo and the BonBono.

The BonGiro is a real outdoor fireplace suitable for both in the garden and under a roof with a smoke outlet. Including the stove pipe, the outdoor fireplace is 125 cm high.

H 130 cm Ø 55 cm
Incl. spark screen and rotating grill.

■ SKU 5501



BONPYRA

The BonPyra is a beautiful patio fireplace with a height of 160 cm and a diameter of 50 cm at the bottom.

It is equipped with a special tray to collect the ashes. A true eye catcher!

H 160 cm Ø 50 cm
Incl. spark screen and ash tray.

■ SKU 5003





BONFEU

PRODUCT ACCESSORIES



Connector Ø100/120 | SKU CN120.100
Connector Ø100/120 R | SKU CN120.100R



Connector Ø100 90° R | SKU CN100.900R
Connector Ø100 90° | SKU CN100.900



Connector Ø100 45° R | SKU CN100.450R
Connector Ø100 45° | SKU CN100.450



Pipe M 440mm Ø 100mm | SKU CH100.440R
Pipe M 440mm Ø 100mm | SKU CH100.440



Pipe L 660 mm Ø 100 mm | SKU CH100.660R
Pipe L 660 mm Ø 100 mm | SKU CH100.660



PRODUCT ACCESSORIES PROTECTION



Premium raincover Small
for BonGianoSP | SKU C3000
Premium raincover Medium
for BonSolo | SKU C3400



Raincap Ø 100 mm | SKU RC100
Raincap Ø 120 mm | SKU RC120
Raincap Ø 140 mm | SKU RC140
Raincap Ø 180 mm | SKU RC180



Premium raincover Large
for BonTino/BonGianoLP/BonCarre | SKU C3500
Premium raincover XLarge
for BonBono/BonPyra/BonSelo/BonTon40 | SKU C4500



Premium raincover Small Round | for FB3.600 / FH3.600 / VBP6.600 VGR6.00 | SKU C6000
Premium raincover Medium Round | for FB3.800 / FH3.800 / VBP6.800 VGR6.800 | SKU C8000
Premium raincover Large Round | for FB3.100 / FH3.100 / VBP6.100 VGR6.100 | SKU C10000
Premium raincover XLarge Round | for FB3.1200 / FH3.1200 / VBP6.1200 VGR6.1200 | SKU C12000



THE ORIGINAL

experience moments of warmth and atmosphere



BONBINI

H 117 cm Ø 29 cm

■ SKU 2901



BONSELO

H 147 cm Ø 39 cm

Incl. grill grid.

■ SKU 3901

Our classic fireplaces of the BonFeu brand. These are specifically designed as terrace fireplaces that can also be used on the patio or lawn. After all these years, they have not lost any popularity and are a proven success.



BONBIZA

The BonBiza is much more than just a barbecue. The baking tray has a diameter of 80 cm and is 6 mm thick, which makes it extremely suitable as a cooking and baking surface. The BonBiza is also provided with adjustable feet to create optimal stabilisation.

H 100 cm Ø 80 cm Incl. grill grid.

■ SKU base+bowl: 8001 ■ SKU base+bowl: 8001R



Note: This product consists of two boxes.

- SKU base: 8001BS
- SKU bowl: 8003
- SKU base: 8001RS
- SKU bowl: 8003R



BONBIZA OPEN

Still just more than a barbecue, but with less body. This BonBiza Open offers space for wood storage and therefore uses all the space very efficiently! Both available in black and rust, the plancha has a diameter of 80 cm and a thickness of 6 mm.

H 100 cm Ø 80 cm Incl. grill grid.

■ SKU base+bowl: 8002 ■ SKU base+bowl: 8002R



Note: This product consists of two boxes.

- SKU base: 8002BSO
- SKU bowl: 8003
- SKU base: 8002RSO
- SKU bowl: 8003R



BONFEU



BONBIZA XL AND XL OPEN

We have developed the BonBiza XL especially for larger groups, which offers the same functions and convenience as the other BonBizas, but with a much larger baking and grilling surface. The Standard 120 also fits on the BonBiza XL for even more cooking options.

H 100 cm Ø 98 cm Incl. grill grid.

■ SKU base+bowl: 10001R ■ SKU base+bowl: 10002R

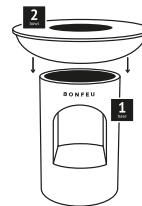

Note: This product consists of two boxes.

■ SKU base: 10001RSO
 ■ SKU bowl: 10001R
 ■ SKU base: 10002RSO
 ■ SKU bowl: 10002R



BONBIZA ISLAND

Like our popular BonBizas, the BonBiza-Island is more than a standard barbecue. Next to the fire bowl of this mobile outdoor kitchen, there is room for our BonFeu Butcherblock. And under the worktop there is space for various cooking accessories and for extra logs.

The stable and beckoning wheels make it easy to put it anywhere in your garden.

And together with BonFeu's cooking accessories, (see page 42) the Island is a culinary addition to your garden.

135x65x85 cm Ø 80 cm Incl. grill grid.

■ SKU base: 8001RIM

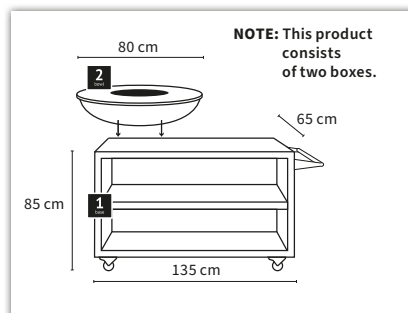

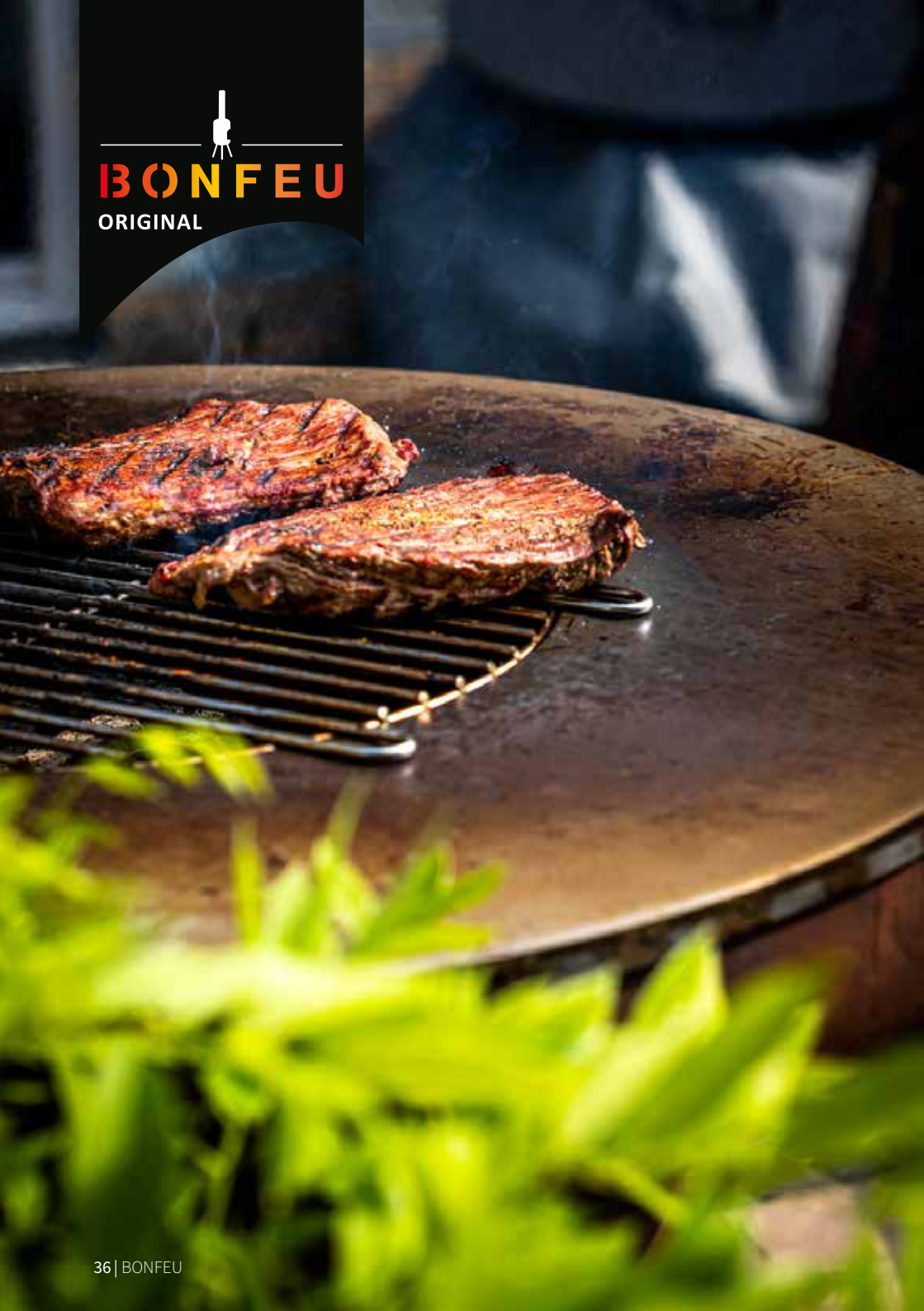

BONBIZA ISLAND XL

And with the BonBiza Island XL, the bowl is almost 20 cm larger in diameter. So extra space for baking on the plancha. Of course very convenient for larger groups. Next to the fire bowl of this mobile outdoor kitchen, there is also room for our BonFeu Butcherblock. The stable and beckoning wheels make it easy to put it anywhere in your garden. And together with BonFeu's cooking accessories, (see page 42) the Island is a culinary addition to your garden.

135x85x65 cm Ø 100 cm Incl. grill grid.

■ SKU base+bowl: 10001R

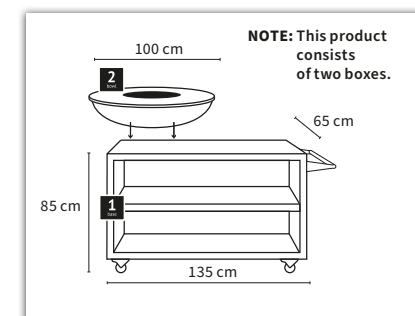

COOKING ACCESSORIES

BonFeu offers a selection of high-quality chopping boards and butcher blocks – the perfect tools for any barbecue enthusiast. Each board is handmade from solid beech wood and features a practical juice channel to keep your workspace clean. The butcher blocks are made from end grain beech wood, which is gentler on your knives and offers extra durability. They are specially designed to fit perfectly on the BonBiza Islands, but are also ideal for use on their own.



Chopping Board | SKU BCB



Butcher Block | SKU BBB



Butcher Block Large | SKU BBBL

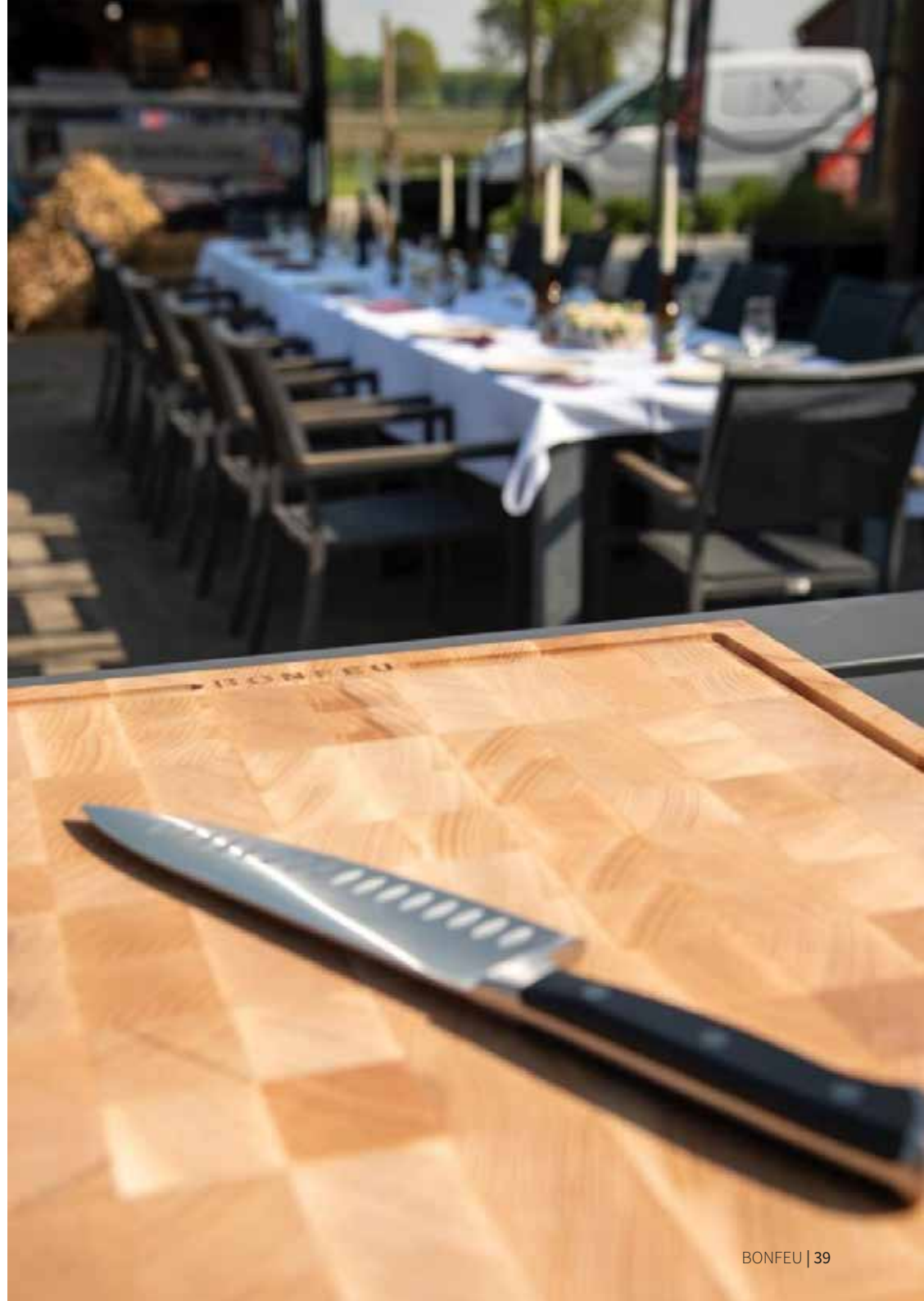



LIDS FOR BONBIZA'S AND BONBOWL'S

To optimally protect your BonBiza or BonBowl against rain, we have developed the BonFeu Lids. Only in black and available in three sizes. The LID80 is for the BonBiza's, Islands, the BonBowl 80 and the BonBowl 80 Plus.



Lid Ø100 | SKU LID100



Lid Ø80 | SKU LID80



Lid Ø60 | SKU LID60



COOKING ACCESSORIES BONBIZA'S AND ISLAND'S

The BonBiza and the BonBiza Island are the ideal outdoor kitchens. Especially with these accessories. With the raised stand in combination with the heavy grill or skewer ring you expand your cooking possibilities. You can even transform them into a real pizza oven.

These accessoires can also be used on a BonFeu fire bowl with plancha 80. We have other grill stands for the plancha 60, 100 and 120 and the BonBiza XL. (See page 55)



BonPizza | SKU BPO



Foodbumper 80 | SKU BF 80



Skewers ring | SKU BRS



Grill Standard | SKU BS80

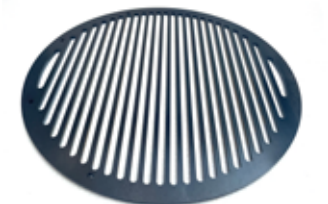

Grill | SKU BGS



COOKING ACCESSORIES SPECIALS



Set V-shape skewers | SKU BSK



Spatula | SKU STB



Oilcan Stainless steel | SKU BOC



Pizzaspatula | SKU BBPS



Pizzawheel | SKU BPW



FIRESTARTERS

Wood wool firelighters for effectively lighting your BBQ and/or firewood. They are light, dry and catch fire quickly. Made with stearin. Stearine makes wood wool harder, more durable and ensures a nice, stable flame. So without chemical and harmful substances. Therefore safer and more environmentally friendly in use.



Woodwool 0,7 kg | SKU BW.01



Woodwool 1,5 kg | SKU BW.02



COOKING ACCESSORIES SPECIALS

To protect yourself against the heat and grease splashes, we have a leather apron.
Of course, leather gloves should not be missing.
And our leather products are complete with the handy and sturdy log bag.



Apron | SKU BAB



Gloves | SKU BGL



Logbag | SKU BLB



BONBOWL

Available in 5 sizes (Ø 60 cm, Ø 80 cm, Ø 100 cm, Ø 120 cm and Ø 150 cm) and made of corten steel.

A fire bowl that will not look out of place in your garden. The BonBowls can also be used for cooking with our complementary plancha's, grills or Broiling Board.

- Ø 60 cm ■ SKU FB3.600C
- Ø 80 cm ■ SKU FB3.800C
- Ø 100 cm ■ SKU FB3.100C
- Ø 120 cm ■ SKU FB3.120C
- Ø 150 cm ■ SKU FB3.150C



BONBOWL PLUS

The BonBowl Plus offers the same firebowl, but has 3 legs that moves it slightly from the ground. The handles attached to the firebowl make the product easy to move.

Plancha's and grills for the firebowls can be found on page 53.

- Ø 60 cm ■ SKU FH3.600C
- Ø 80 cm ■ SKU FH3.800C
- Ø 100 cm ■ SKU FH3.100C



COOKING ACCESSORIES BONFEU FIREBOWLS

It's not only the BonFeu fireplaces and firepits that are suitable for outdoor cooking. The firebowls now offer cooking possibilities due to our latest product introductions. The specially developed plancha's and grills turn your firebowl into a real outdoor cooking experience. Available in 4 sizes (60, 80, 100 and 120) BonFeu offers also possibilities for the bigger firebowls.

The half shaped plancha's and grills can be combined, to experience the best of both products.





COOKING ACCESSORIES FIREBOWLS WITH PLANCHA

As for the BonBiza, our cooking accessories can be used on all planchas provided they have the right stand. Below is an overview.



Grill Standard 60 | SKU BS60

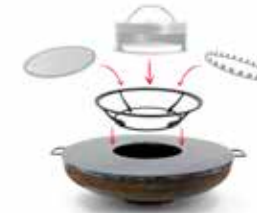

Suitable on:
BonPlancha 60 | VBP6.600

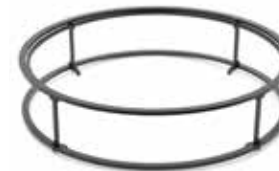

Grill Standard 80 | SKU BS80

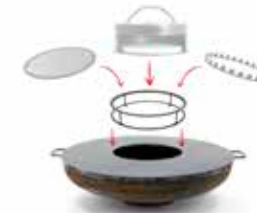

Suitable on:
BonPlancha 80 | VBP6.800
BonBiza | 8001 + 8001R
BonBiza Open | 8002 + 8002R
BonBiza island | 8001RIM



Grill Standard 100 | SKU BS100

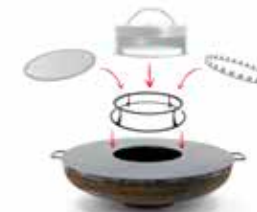

Suitable on:
BonPlancha 100 | VBP6.1000



Grill Standard 120 | SKU BS120

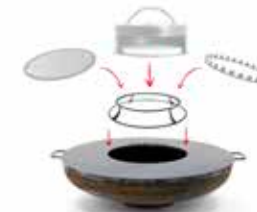

Suitable on:
BonPlancha 120 | VBP6.1200
BonBiza XL | 10001R
BonBiza Open XL | 10002R
BonBiza island XL | 10001RIM



COOKING ACCESSORIES FIREBOWLS

We also have a special broilingboard for our firebowls to smoke, for example, delicious salmon.



Broilingboard | SKU WFB



THE BONBRIDGE

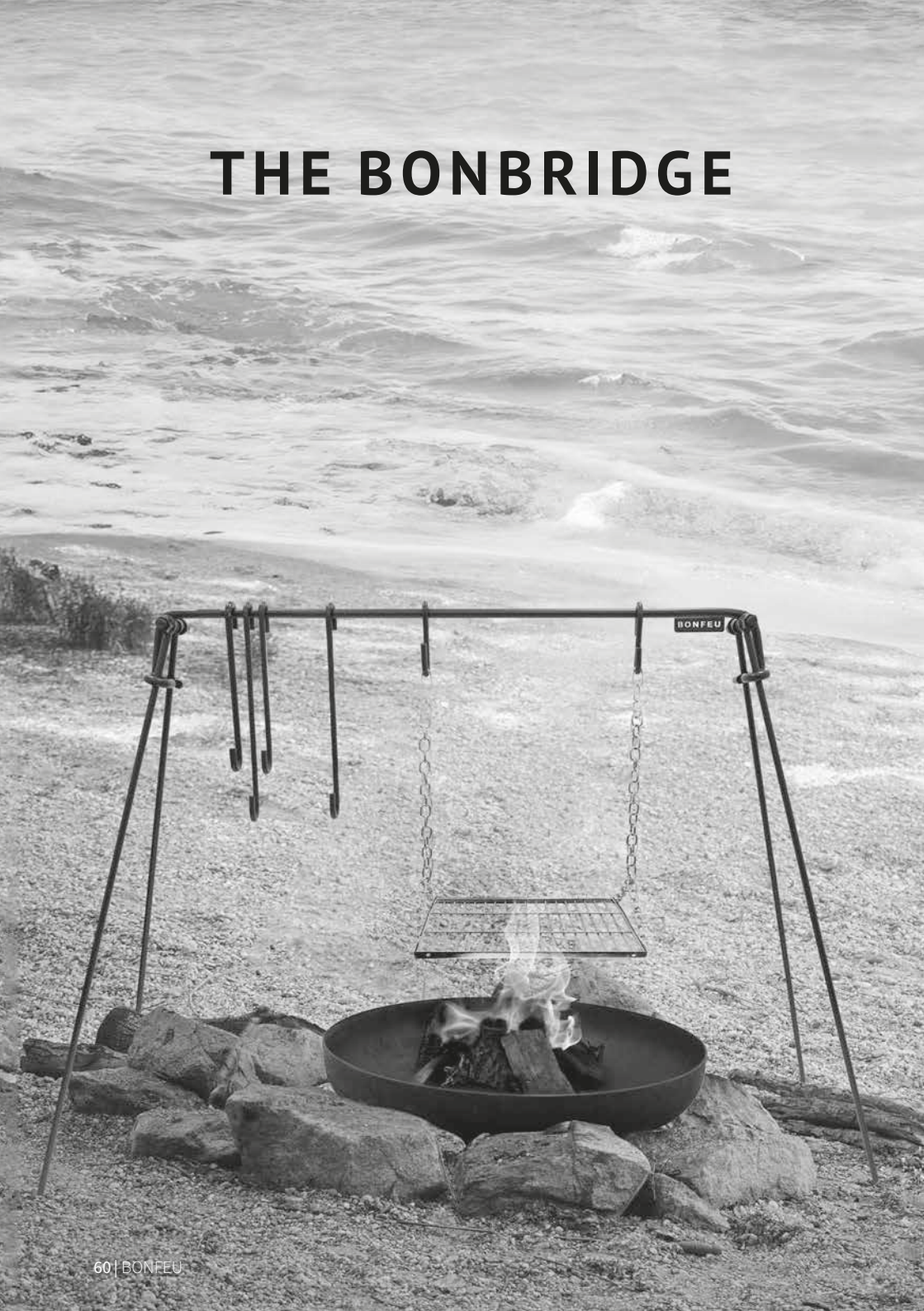

COOKING ACCESSORIES FIREBOWLS

The BonFeu fire bridge is a great accessory for outdoor cooking. It is the perfect addition to our fire bowls. This BonFeu fire bridge offers multiple ways to cook above your fire bowl. The fire bridge comes with various hooks and can therefore be used for different heights. For example, you can hang a pan of soup on one of the various hooks or grill the tastiest dishes on the stainless steel grill. The stainless steel grill is optional.

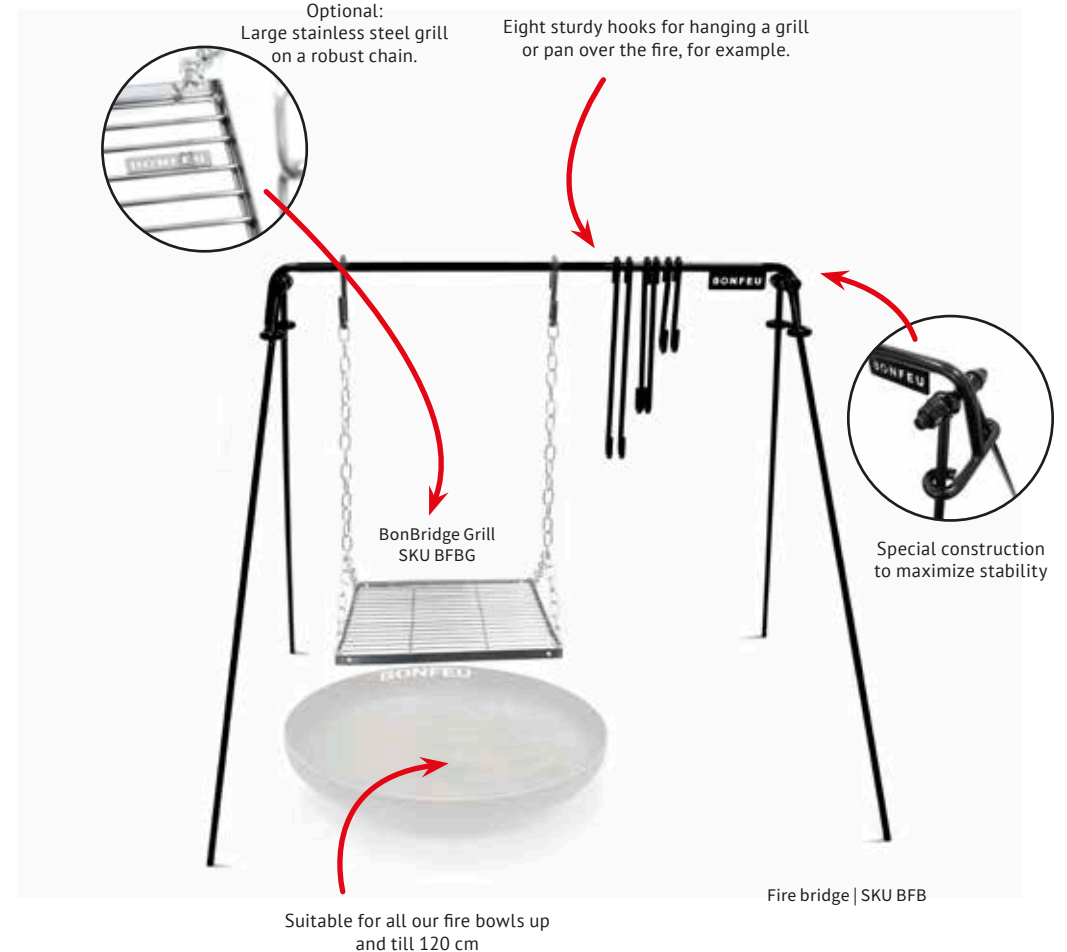

COOKING ACCESSORIES FIREBOWLS AND BONBIZA

The BonFeu rotisserie set is an ideal, stainless steel construction for preparing large pieces of meat or poultry. The set consists of two uprights that fit the Plancha 60, 80, and 100. Between these two uprights, a stainless steel intermediate tube is stretched and fixed so that the uprights stand firmly.

To prepare various large pieces of meat, a set of large and a set of small clamps are included.



The S hook can be used for hanging a cooking pot above the fire

Easy to adjust for different sizes of planchas.

The sturdy skewer has a heat-resistant wooden handle.

Motor | SKU BFMRS

Suitable for the 60, 80 and 100 BONFEU plancha's.

Possibility of running the skewer automatically and manually

Rotisserie set | SKU BFRS





BonFeu B.V.

Jellinghausstraat 3C • 5048 AZ • Tilburg • The Netherlands
T (sales) +31 (0)13 33 33 006 • E info@bonfeu.nl • I www.bonfeu.com

